

# MicroSpeed Power Modules

& Power Connectors



Original size MicroSpeed Power Module 5 pin

ED. 02 | 03.2021

Catalog E 074587

# MicroSpeed Power Modules

**HIGH-POWER. INTERCONNECT. SOLUTIONS.** —

**GENERAL**

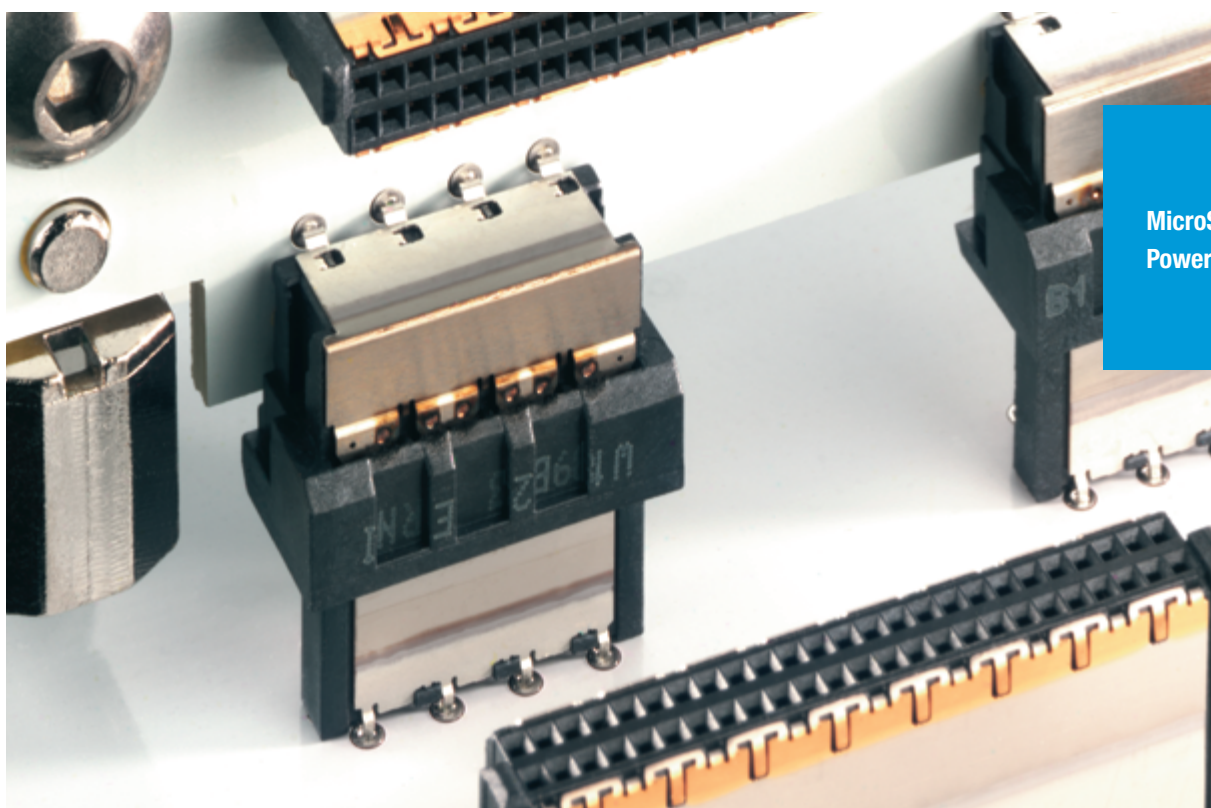

This complementary range of Power Module connectors, with 2.0 mm contact pitch, fulfils the need for miniaturized and high reliability power systems, and offers a large number of options for mezzanine applications. One of its unique features is its high current-carrying capacity in comparison to its small size. Therefore, the system is ideally suited for use with small, high performance devices such as CPUs, drives, LCD panels, etc.

Providing a variety of height versions of the male and female connectors, the Power Module series enables stacking heights from 5 mm to 20 mm. Subsequently, almost every need for different PCB arrangements can be addressed. Another major advantage is the multiple-connector mating capability, which allows the

mating of more than one connector pair at the same time.

The SMT connectors meet all the needs of fast automatic assembly machines. They are manufactured and 100% inline quality checked by machine to ensure high coplanarity and optimized soldering. The layout is designed with an optimal solder pad size to guarantee high retention forces. The integrated 3-point double beam female contact ensures durable low-contact resistance over the whole lifecycle.

The contacts are post plated, leaving no bare edges in the contact and solder areas. The connectors are equipped with polarized positioning pegs, and the connector plating is lead free, complying with the European RoHS directive.

# MicroSpeed Power Modules

## CONCEPT —

### FEATURES

<b>No. of Pins</b>	5
<b>Current rate</b>	up to 18 A per contact
<b>Temperature range</b>	-55 °C to 125 °C
<b>Board-to-Board heights</b>	5 - 20 mm
<b>Termination technology</b>	SMT, SMT/THR und THR
<b>Applications</b>	Orthogonal Mezzanin Coplanar
<b>Variants</b>	Male and female connectors Non-Blind Mate and Blind Mate Shielded

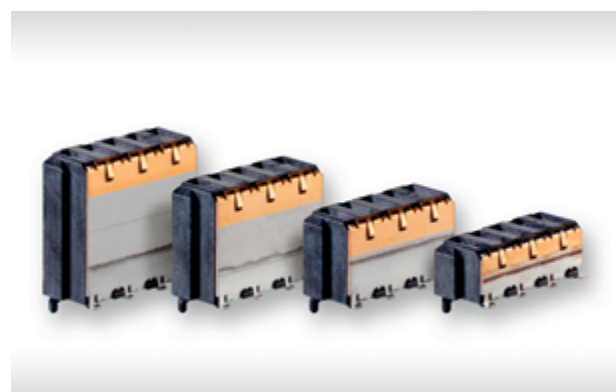

# MicroSpeed Power Modules

## CONCEPT —

### CAPABILITIES

Stacked boards  
(Mezzanine)

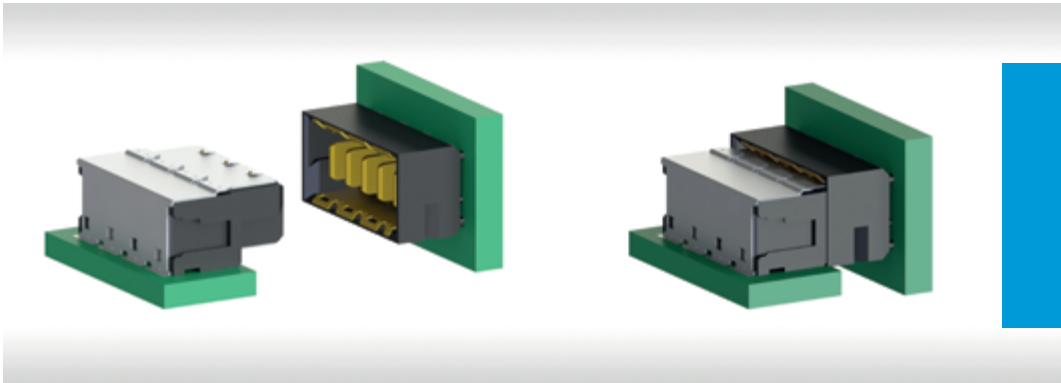
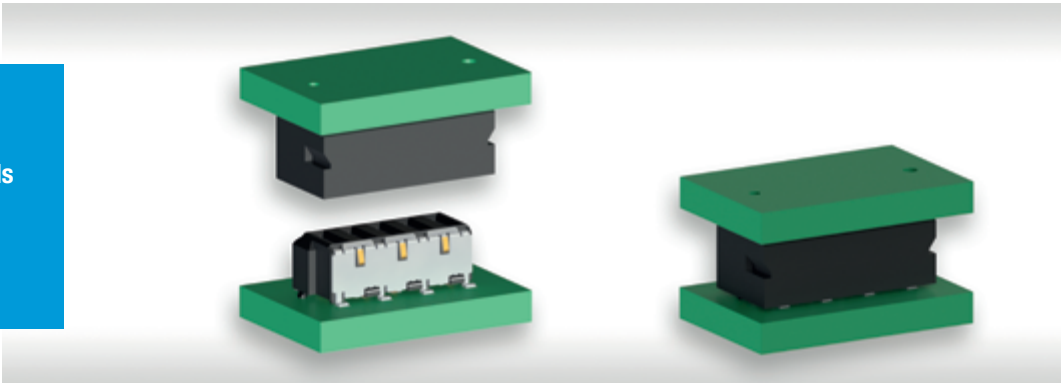

Orthogonal  
boards

Extender card  
(coplanar)

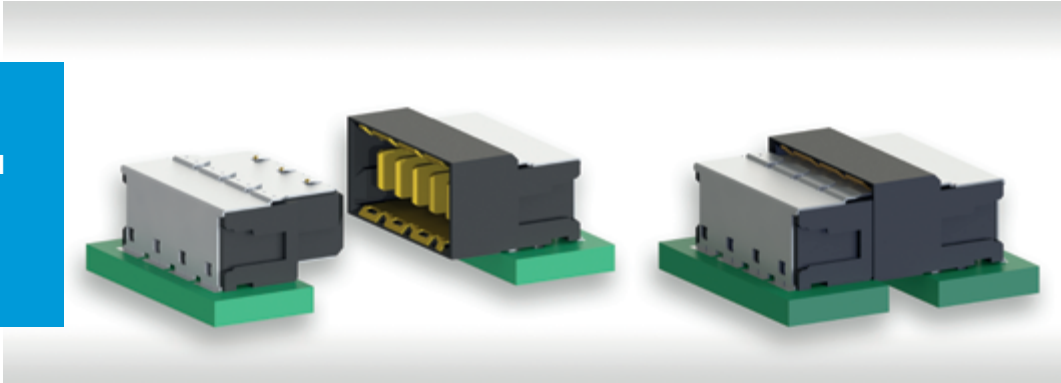

# MicroSpeed Power Modules

## ADVANTAGES —

### BLIND MATE DESIGN

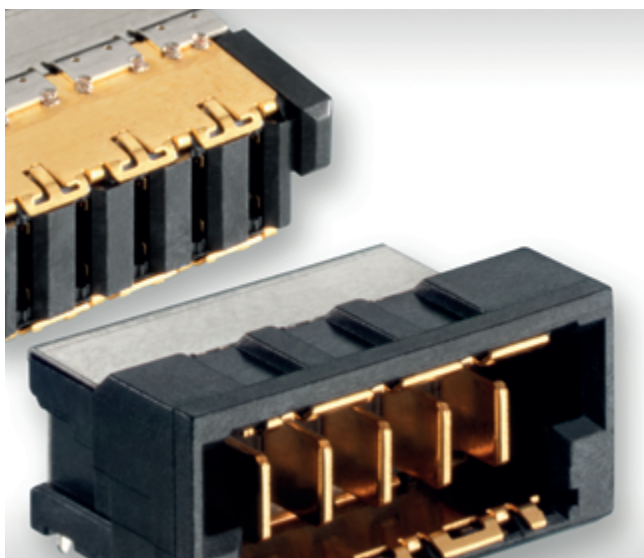

- Blind Mate versions feature
  - a distinctive polarization of the mating face
  - extended guides to capture the mating connector
  - increased wall thickness
  - slightly larger footprint
- Self-aligning feature, guide the Blind Mate connectors into correct mating position
- Designed to ensure consistent and reliable mating even in difficult conditions
- Robust connectors for harsh environments
- Shrouded housing protect contacts; high-temperature resistant materials
- Distinctive polarization avoids mismating

### CONTACT DESIGN

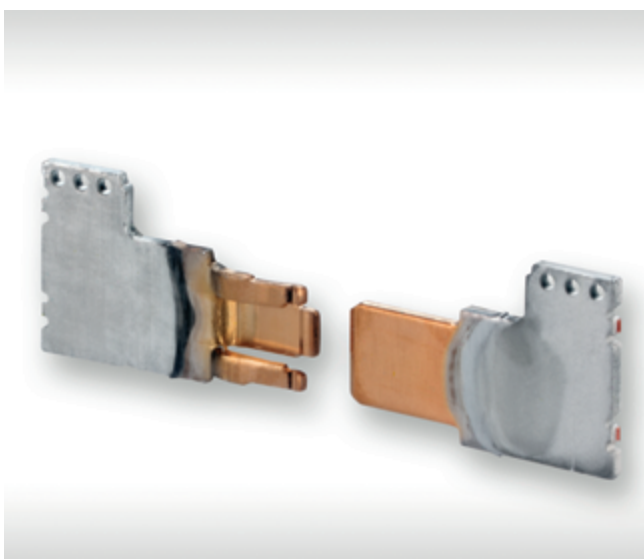

- Superior reliability due to dual-beam female contact design:
  - 3-point dual-beam female contact
  - Homogeneous, rolled surface guarantees secure contact
  - Wide contact surface between mated pair
  - Low surface roughness minimizes abrasion
  - Low contact resistance
- Provides excellent misalignment tolerance/ tolerance compensation
- Wipe length 1,5 mm
- Durability: > 500 mating cycles
- Contact finish: Au plating

# MicroSpeed Power Modules

## ADVANTAGES —

### PICK & PLACE PAD

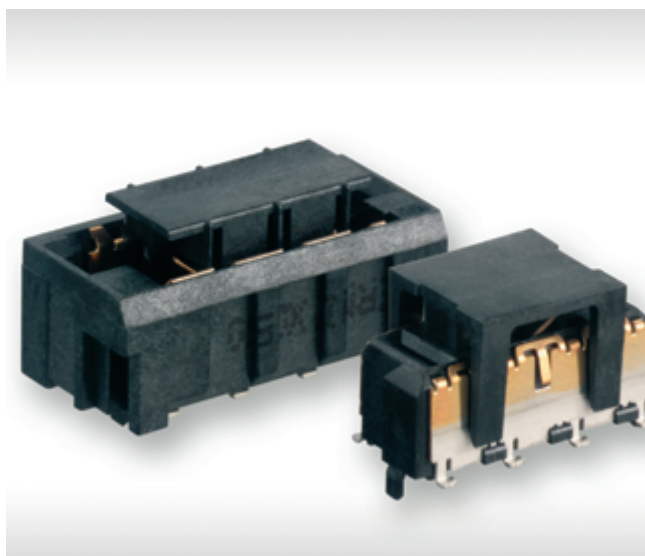

- Pick and place pad for vacuum pick-up nozzles provided for straight connectors
- High-temperature plastic to withstand reflow solder temperatures
- Right angled versions are commonly picked-up at the smooth shield surface

### TERMINATION



- SMT: SMT high power blade contacts, SMT shield terminals
  - Double sided board assembly
  - 100% tested coplanarity of  $\leq 0.1$  mm leads to excellent soldering results
- SMT/THR: SMT high power blade contacts, THR shield terminals
  - THR shield terminals provide strong mechanical solder joint for demanding applications
- THR: THR high power blade contacts, THR shield terminals
  - THR shield terminals provide strong mechanical solder joint for demanding applications

# MicroSpeed Power Modules

## CONCEPT —

### MICROSPEED SIGNAL CONNECTORS



MicroSpeed signal connectors supplement the MicroSpeed Power Modules and enable a fast data transmission.

- Miniaturisiertes Design im 1-mm-Raster
- Data rate up to 25 Gbit/s
- Reliable dual-beam female contact
- Optional THR shield terminals provide strong mechanical resistance particularly suitable for industrial applications subject to mechanical stress
- Applications: orthogonal, mezzanine, coplanar
- Board-to-Board heights: 5 - 20 mm

### VARIOUS TYPES

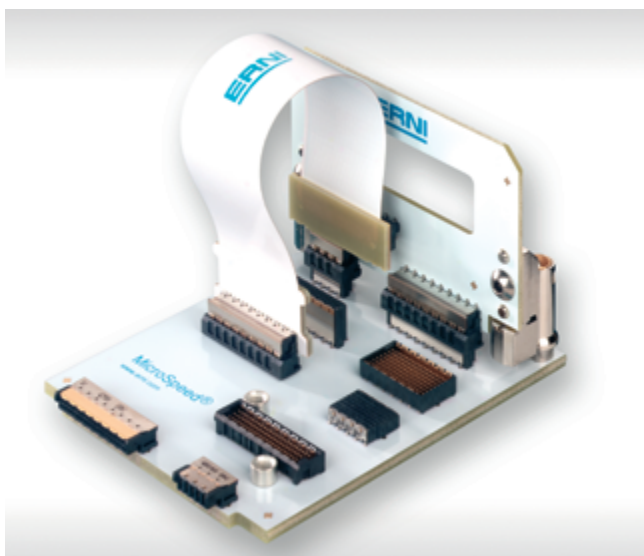

Various types of Power Modules allow for virtually every PCB arrangement: mezzanine, backplane-to-daughtercard or extender card applications.

- Male and female connectors
- Vertical and right angle
- 2-, 3- und 7-reihig
- Various connector heights provide for flexible board stacking
  - Male: 1 / 2 / 9 / 10 mm
  - Female: 4 / 6 / 8 / 10 mm
- Standard (non-Blind Mate) and robust Blind Mate versions
- EMV versionen
- SMT versionen and SMT/THR shielding types

# MicroSpeed Power Modules

## PROCESSING —



### TAPE AND REEL PACKAGING

---

Transport safe packaging and fully automatic assembly

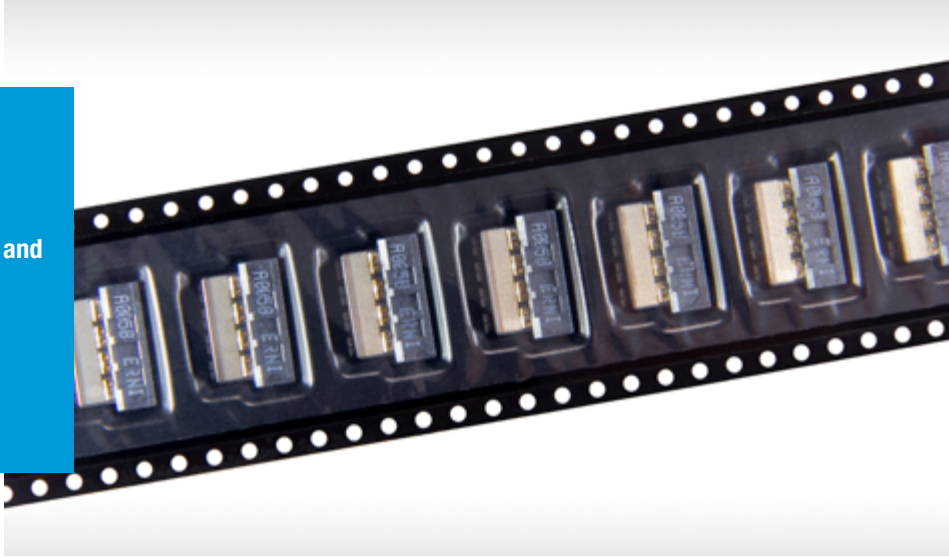

### FULLY AUTOMATIC ASSEMBLY AND REFLOW SOLDERING

---

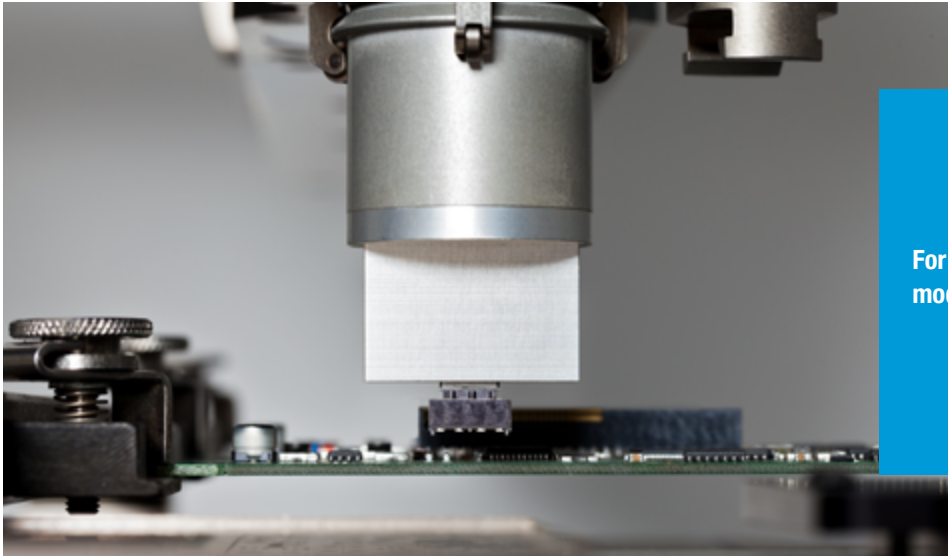

For efficient processing on modern assembly lines



# MicroSpeed Power Modules

## MATING CONDITIONS

### WIPE LENGTH AND TOLERANCES

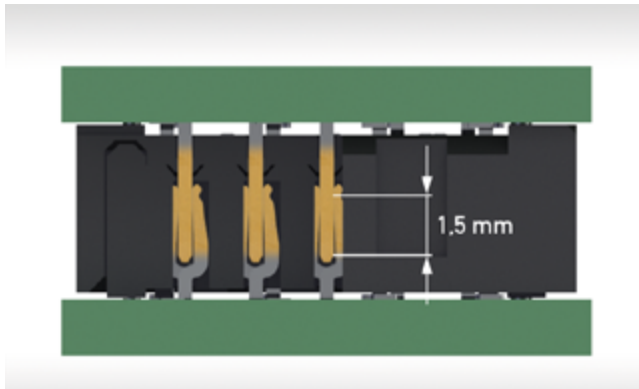

Wipe length

- 1.5 mm
- Blind mate version

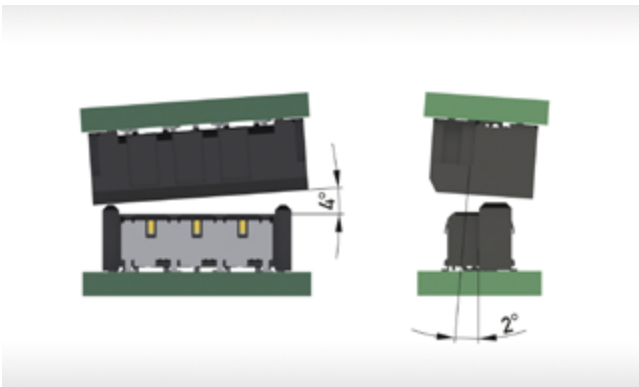

Allowed inclination for secure self-centering

- Angular inclination longitudinal 4° (1° in combination with misalignment)
- Angular inclination transverse 2°
- Blind mate version

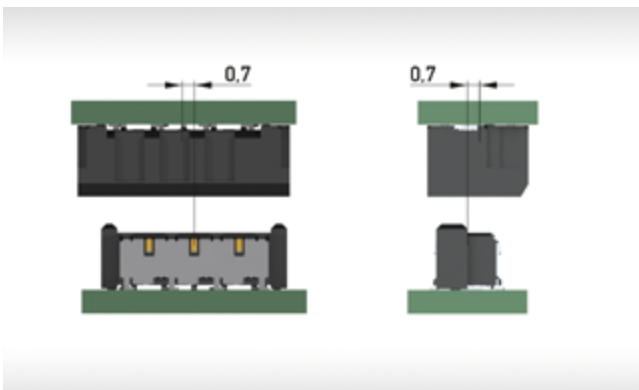

Allowed misalignment for secure self-centering

- Misalignment tolerance of 0,7 mm
- Blind mate version

# MicroSpeed Power Modules

## BOARD-TO-BOARD HEIGHT

### FLEXIBLE BOARD STACKING

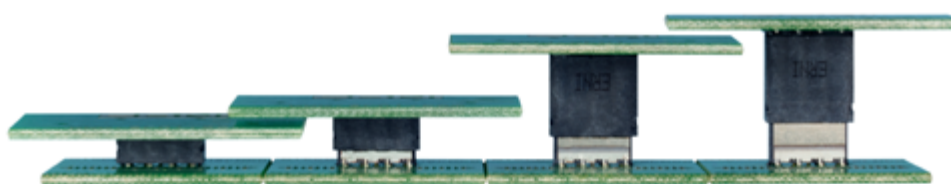

Board-to-Board Height	Male Stacking Height	Female Stacking Height
5 – 6 mm	1 mm	4 mm
6 – 7 mm	2 mm	4 mm
7 – 8 mm	1 mm	6 mm
8 – 9 mm	2 mm	6 mm
9 – 10 mm	1 mm	8 mm
10 – 11 mm	2 mm	8 mm
11 – 12 mm	1 mm	10 mm
12 – 13 mm	2 mm	10 mm
13 – 14 mm	9 mm	4 mm
14 – 15 mm	10 mm	4 mm
15 – 16 mm	9 mm	6 mm
16 – 17 mm	10 mm	6 mm
17 – 18 mm	9 mm	8 mm
18 – 19 mm	10 mm	8 mm
19 – 20 mm	9 mm	10 mm
20 – 21 mm	10 mm	10 mm

# MicroSpeed Power Modules

## CHARACTERISTICS —

### TECHNICAL DATA

Description	Standard	MicroSpeed Power Modules
Climate category	DIN EN 60068-1 test b	55 / 125 / 56
Temperature range		-55 / 125 °C
Current rating per contact	IEC60512 test 5b	up to 18 A
Air- and creepage (min.)		contact – contact 1.5 mm contact – ground 0.9 mm
Operating voltage	IEC 60664	The permissible operating voltages depends on the customer application and on the applicable or specified safety requirements. Insulation coordination according to IEC 60664-1 has to be regarded for the complete electrical device. Therefore, the maximum creep- age and clearance distances of the mated connectors are specified for consideration as a part of the whole current path. In practice, reductions in creepage or clearance distances may occur due to the conductive pattern of the printed board or the wiring used, and have to be taken into account separately. As a result the creepage and clearance distances for the application may be reduced compared to those of the connector.
Dielectric strength	IEC 60512 test 4a	contact – contact 500 V <sub>rms</sub> contact – ground 500 V <sub>rms</sub>
Contact resistant	IEC 60512 test 2a	< 4 mΩ
Insulation resistant	IEC 60512 test 3a	> 10 <sup>4</sup> MΩ
Vibration, sine	IEC 60512 test 6d	10 – 2000 Hz 20 g
Contact disturbance (while vibration test)	IEC 60512 test 2e	< 1 μs
Shock, halfsine	IEC 60512 test 6c	50 g 11 ms
Contact disturbance (while shock test)(während Schocktest)	IEC 60512 test 2e	< 1 μs

# MicroSpeed Power Modules

## CHARACTERISTICS —

Description	Standard	MicroSpeed Power Modules
Mechanical Operation	IEC 60512 test 9a	500 mating cycles
Insertion and withdrawal force	IEC 60512 test 13b	< 5 N
Gauge retention force	IEC 60512 test 16e	> 0.5 N
<b>Processing Conditions</b>		
Reflow soldering temperature max.	JEDEC J-STD-020	10 s at 260 °C
Coplanarity		< 0.1 mm
<b>Housing Material</b>		
Insulation body		LCP
CTI value	IEC 112	175
UL flame rating	UL 94	V-0
UL file plastic material		E83005
MSL	JEDEC J-STD-020	Level 1
<b>Contact Material</b>		
Base material		Cu alloy
Mating area		Gold plating
Termination area		Sn
<b>Environment Compatibility</b>		
Recycling		no flame-retardent additives, no toxic additives allow easy recycling
<b>Product Approval</b>		
UL/CSA		E84703

# MicroSpeed Power Modules

## RIGHT ANGLE FEMALE

### PRODUCT SPECIFICATION



- MicroSpeed Power Module
- 5 pin
- Current rating up to 18 A per contact
- SMT or THR termination
- Tape and reel packaging
- For available part numbers please refer to our website

### DIMENSIONAL DRAWINGS

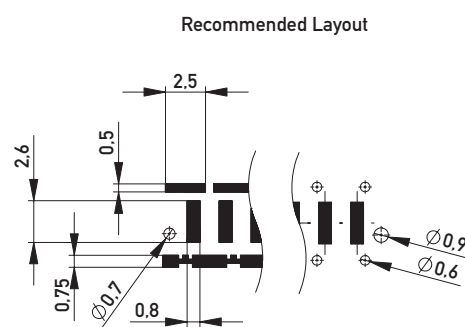
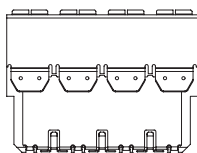
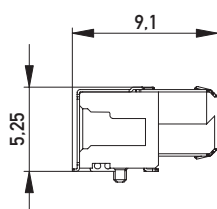
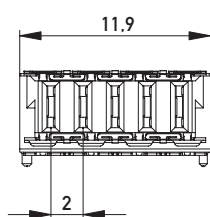

# MicroSpeed Power Modules

## BLIND MATE, RIGHT ANGLE FEMALE

### PRODUCT SPECIFICATION

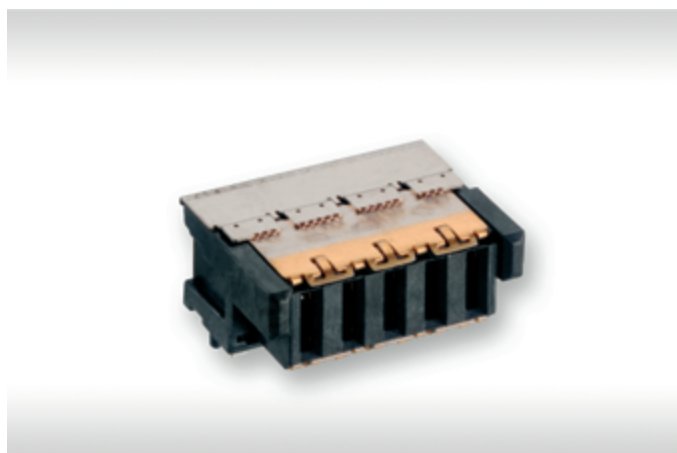

- MicroSpeed Power Module
- 5 pin
- Current rating up to 18 A per contact
- SMT or THR termination
- For robust applications (reinforced side walls)
- Tape and reel packaging
- For available part numbers please refer to our website

### DIMENSIONAL DRAWINGS

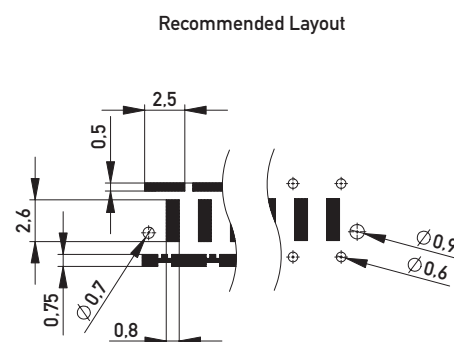
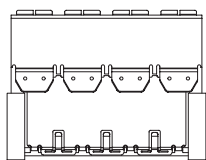
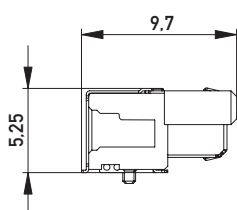
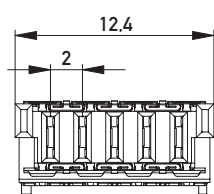

# MicroSpeed Power Modules

## VERTICAL FEMALE

### PRODUCT SPECIFICATION



- MicroSpeed Power Module
- 5 pin
- Current rating up to 18 A per contact
- SMT or THR termination
- Tape and reel packaging
- Heights: 4, 6, 8, 10 mm
- For available part numbers please refer to our website

### DIMENSIONAL DRAWINGS

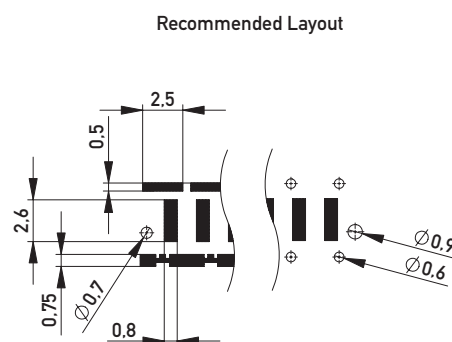
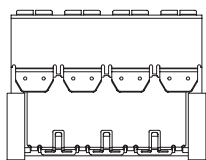
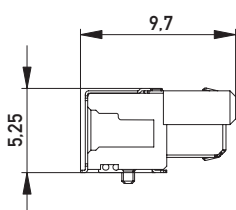
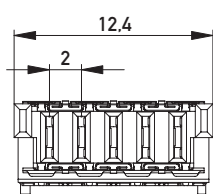

# MicroSpeed Power Modules

## BLIND MATE, VERTICAL FEMALE

### PRODUCT SPECIFICATION



- MicroSpeed Power Module
- 5 pin
- Current rating up to 18 A per contact
- SMT or THR termination
- For robust applications (reinforced side walls)
- Tape and reel packaging
- Heights: 4, 6, 8, 10 mm
- For available part numbers please refer to our website

### DIMENSIONAL DRAWINGS

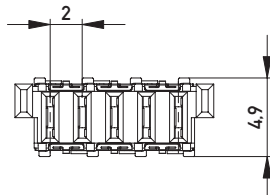
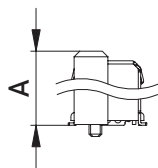
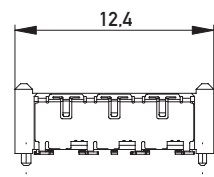

4 mm	3.80
6 mm	5.80
8 mm	7.80
10 mm	9.80
Stacking Height	A

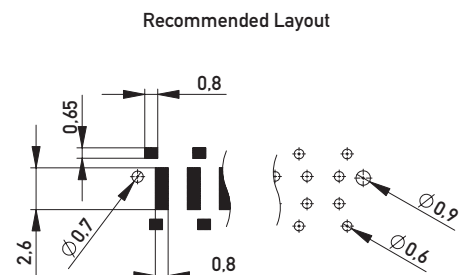



# MicroSpeed Power Modules

## RIGHT ANGLE MALE

### PRODUCT SPECIFICATION



- MicroSpeed Power Module
- 5 pin
- Current rating up to 18 A per contact
- SMT or THR termination
- Tape and reel packaging
- For available part numbers please refer to our website

### DIMENSIONAL DRAWINGS

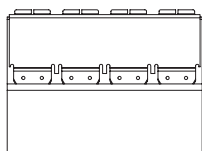
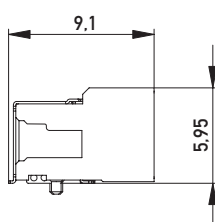
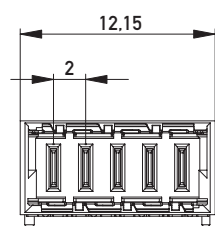

Recommended Layout

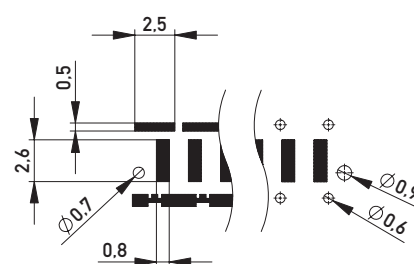

# MicroSpeed Power Modules

## BLIND MATE, RIGHT ANGLE MALE

### PRODUCT SPECIFICATION



- MicroSpeed Power Module
- 5 pin
- Current rating up to 18 A per contact
- SMT or THR termination
- For robust applications (reinforced side walls)
- Tape and reel packaging
- For available part numbers please refer to our website

### DIMENSIONAL DRAWINGS

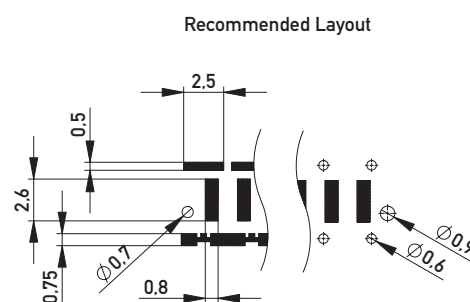
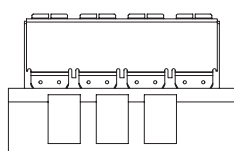
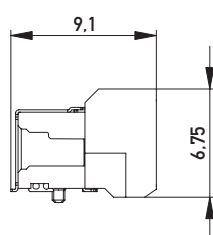
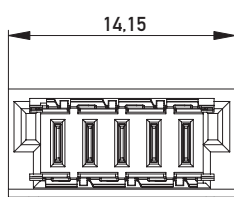

# MicroSpeed Power Modules

## VERTICAL MALE

### PRODUCT SPECIFICATION

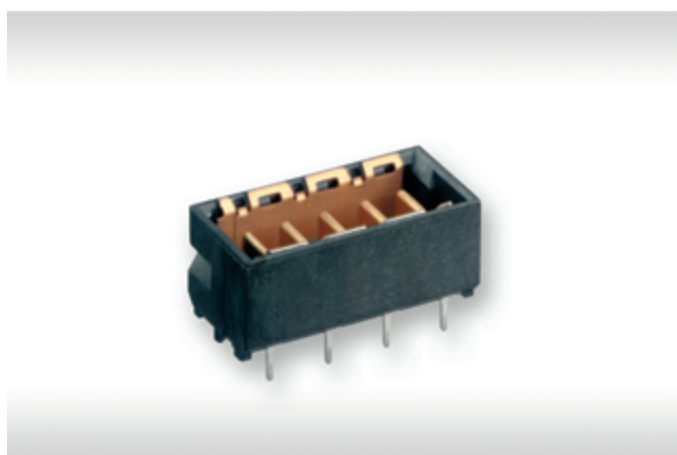

- MicroSpeed Power Module
- 5 pin
- Current rating up to 18 A per contact
- SMT or THR termination
- Tape and reel packaging
- Heights: 1, 2, 9, 10 mm
- For available part numbers please refer to our website

### DIMENSIONAL DRAWINGS

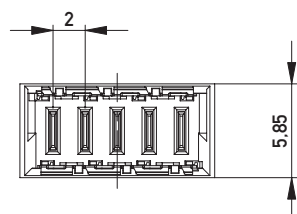
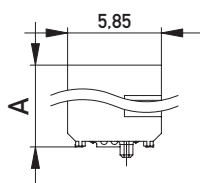
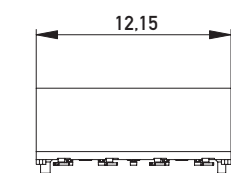

1 mm	6.30
2 mm	7.30
9 mm	14.30
10 mm	15.30
Stacking Height	A

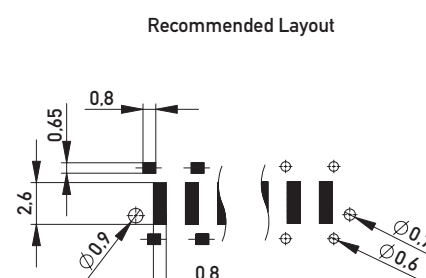

# MicroSpeed Power Modules

## BLIND MATE, VERTICAL MALE

### PRODUCT SPECIFICATION



- MicroSpeed Power Module
- 5 pin
- Current rating up to 18 A per contact
- SMT or THR termination
- For robust applications (reinforced side walls)
- Tape and reel packaging
- Heights: 1, 2, 9, 10 mm
- For available part numbers please refer to our website

### DIMENSIONAL DRAWINGS

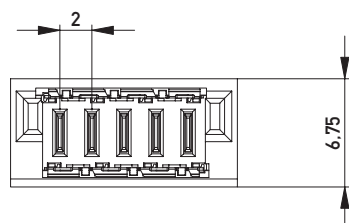
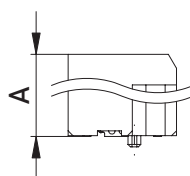
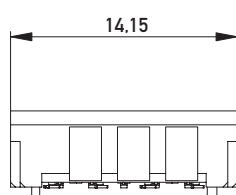

1 mm	6.30
2 mm	7.30
9 mm	14.30
10 mm	15.30
Stacking Height	A

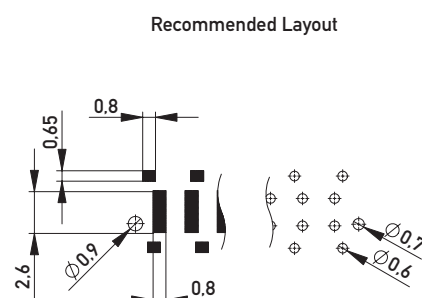

# Power Connectors

## OVERVIEW —

### GENERAL

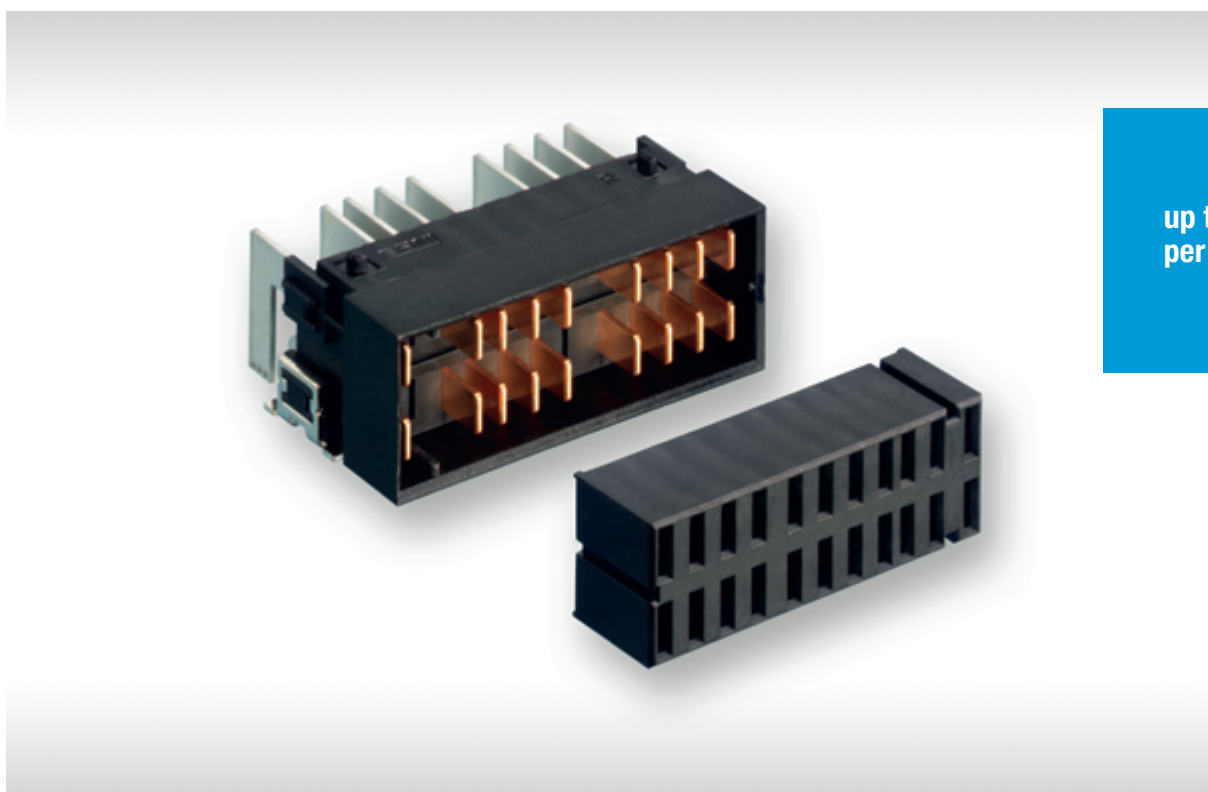

up to 15 A  
per contact

The unshielded power connectors are predestined for highly reliable power and power I/O systems. One of its unique features is its high current-carrying capacity in comparison to its small size. Therefore, the system is ideally suited for use with small, high performance devices.

The connectors meet all the needs of fast automatic assembly machines. They are manufactured and 100% inline quality checked by machine to ensure high coplanarity and optimized soldering. The layout is designed with an optimal solder pad size to guarantee high retention forces. The integrated 3-point double

beam female contact ensures durable low-contact resistance over the whole lifecycle.

The connectors have a pre-assembled pick&place pad and can be processed fully automatically.

Higher operating voltages are possible due to a variable distance between the contacts. This provides a high flexibility in the applications.

# Power Connectors

## CONCEPT —

### VARIOUS TYPES

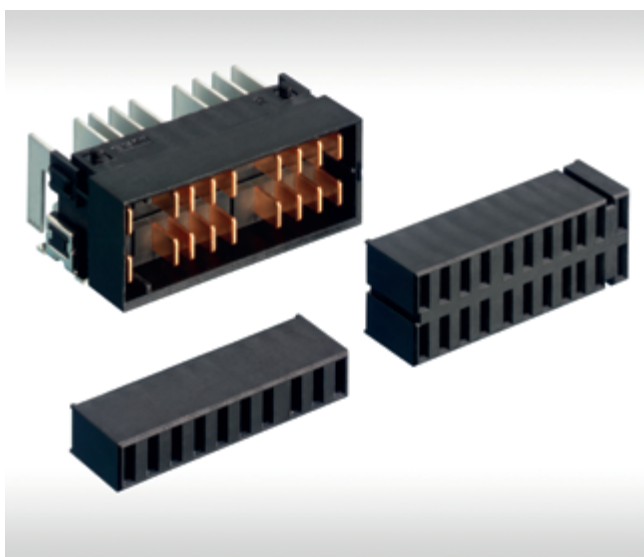

- No. of pins:
  - 7 (up to 10 possible)
  - 9 (up to 22 possible)
  - 18 (up to 22 possible)
  - 20
  - 32 (up to 44 possible)
- Durability: Orthogonal
- Unshielded
- Current rating up to 15 A per contact at 125 °C limit temperature
- Variable contact distance, thus higher operating voltages are possible
- Possible selective placement for higher flexibility in the applications

### SOLDER CLIPS

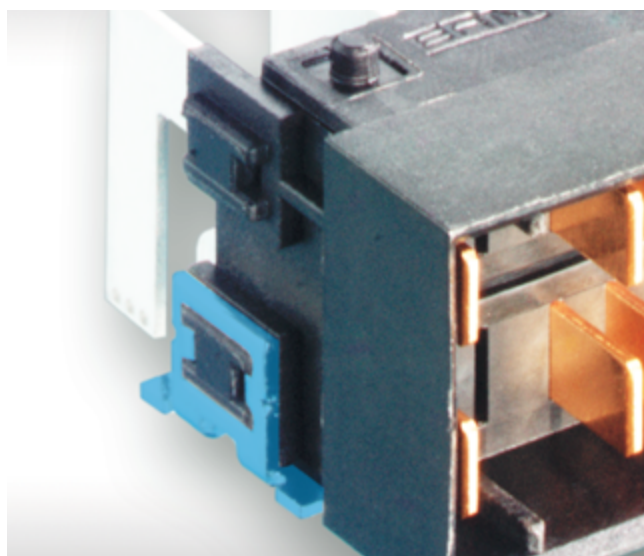

- Robust SMT solder clips for 90° male connectors
- Extremely high shear forces due to form-fit mounting in the housing
- Strain relief

# Power Connectors

## CHARACTERISTICS

### TECHNICAL DATA

Description	Standard	Power Connectors
Climate category	DIN EN 60068-1 test b	55 / 125 / 56
Temperature range		-55 / 125 °C
Current rating per contact	IEC60512 test 5b	up to 15 A
Air- and creepage (min.)		variable
Operating voltage	IEC 60664	The permissible operating voltages depends on the customer application and on the applicable or specified safety requirements. Insulation coordination according to IEC 60664-1 has to be regarded for the complete electrical device. Therefore, the maximum creep- age and clearance distances of the mated connectors are specified for consideration as a part of the whole current path. In practice, reductions in creepage or clearance distances may occur due to the conductive pattern of the printed board or the wiring used, and have to be taken into account separately. As a result the creepage and clearance distances for the application may be reduced compared to those of the connector.
Dielectric strength	IEC 60512 test 4a	contact – contact 750 V <sub>eff</sub>
Contact resistant	IEC 60512 test 2a	< 4 mΩ
Insulation resistant	IEC 60512 test 3a	> 10 <sup>6</sup> MΩ
Vibration, sine	IEC 60512 test 6d	10 – 2000 Hz 20 g
Contact disturbance (while vibration test)	IEC 60512 test 2e	< 1 μs
Mechanical Operation	IEC 60512 test 9a	500 mating cycles
Insertion and withdrawal force	IEC 60512 test 13b	< 5 N
Gauge retention force	IEC 60512 test 16e	> 0.5 N

# Power Connectors

## CHARACTERISTICS —

Description	Standard	Power Connectors
<b>Processing Conditions</b>		
Reflow soldering temperature max.	JEDEC J-STD-020	20 - 40 s at 260 °C
Coplanarity		< 0.1 mm
<b>Housing Material</b>		
Insulation body		PPA
CTI value	IEC 112	600
UL flame rating	UL 94	V-0
UL file plastic material		E53898
MSL	JEDEC J-STD-020	Level 2
<b>Contact Material</b>		
Base material		Cu alloy
Mating area		Gold plating
Termination area		Sn
<b>Environment Compatibility</b>		
Recycling		no flame-retardent additives, no toxic additives allow easy recycling



# Power Connectors

## VERTICAL FEMALE



### PRODUCT SPECIFICATION

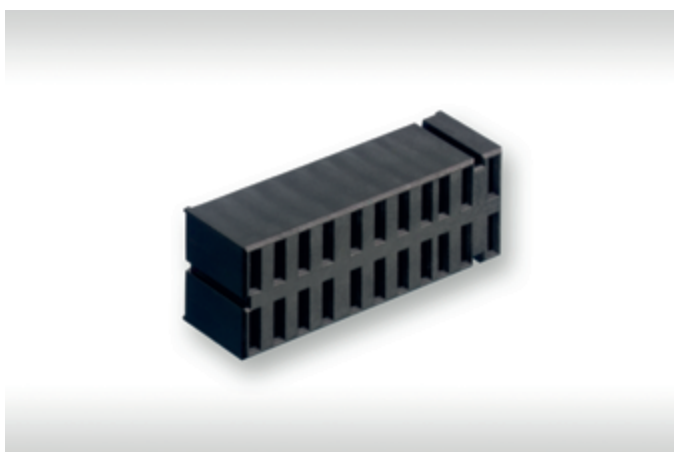

- Unshielded Power Connectors
- 7, 9, 18, 20, 28, 32 pins
- 1- and 2-row
- Current rating up to 15 A per contact
- SMT termination
- Tape and reel packaging
- For available part numbers please refer to our website



### DIMENSIONAL DRAWINGS

#### 20 pin Version

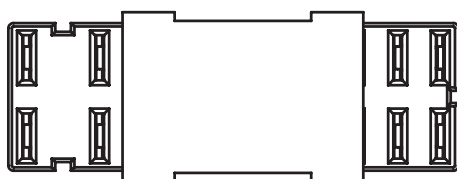
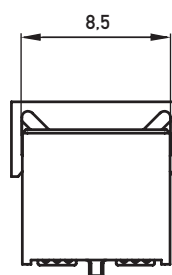
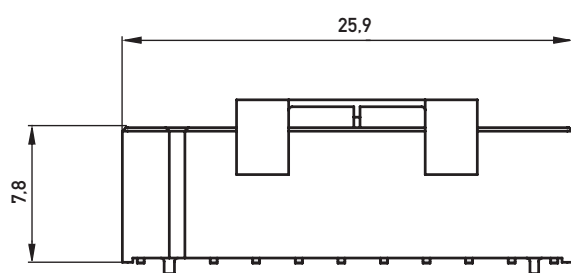

# Power Connectors

## RIGHT ANGLE MALE

### PRODUCT SPECIFICATION

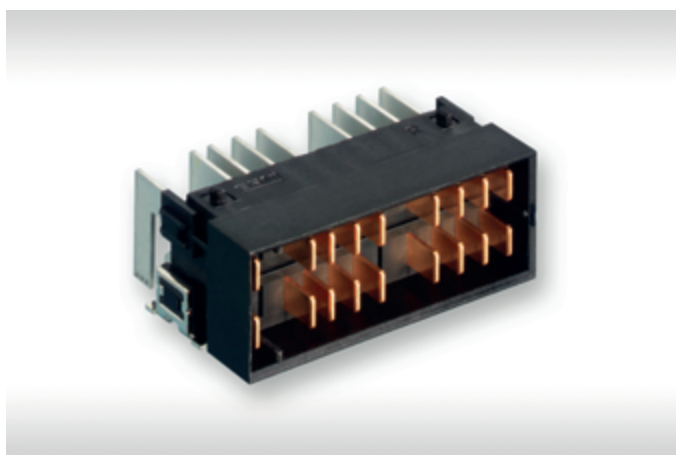

- Unshielded Power Connectors
- 7, 9, 18, 20, 28, 32 pins
- 1- and 2-row
- Current rating up to 15 A per contact
- SMT termination
- Tape and reel packaging
- For available part numbers please refer to our website

### DIMENSIONAL DRAWINGS

#### 20 pin Version

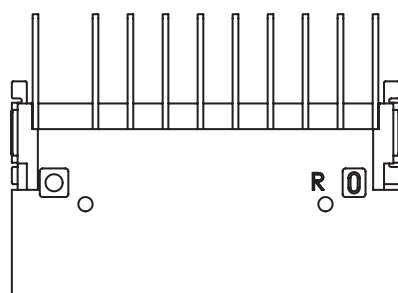
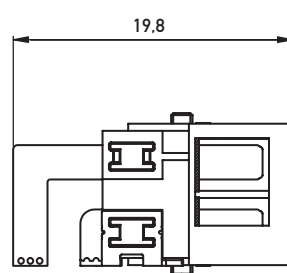
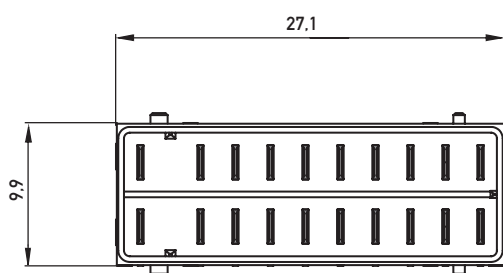





Find your correct contact person  
on [erni.com/locations](https://www.erni.com/locations)